

		ITRONIC LL (STANDARD)	
© ZANUSSI ELETTRODOMESTICI VIA GIARDINI CATTANEO, 3 I - 33170 PORDENONE (ITALY) Fax (0434) 394096	Publication no. 599 32 93-12/4 9602 EN/SERVICE/LF		

INDEX

PRESENTATION	p.	5
Innovative technical characteristics	p.	6
Structural characteristics	p.	8
Control panel	p.	9
CHARACTERISTICS OF THE COMPONENTS	p.	11
Electronic control unit	p.	12-13
Electromechanical control components	p.	14-15
Hydraulic components	p.	16
FUNCTIONAL CHARACTERISTICS	p.	17
Washing system	p.	18-20
Water softener	p.	21-24
CONTROL, SAFETY AND ALARM DEVICES	p.	25
Safety checks	p.	26
Safety devices / Alarms	p.	27-30
Checking the alarm conditions	p.	31
FUNCTIONS AND CONTROLS	p.	33
Functional characteristics of controls	p.	34-36
TROUBLESHOOTING	p.	37
Checking the components for efficiency	p.	38-39
Programming optional features on the ITRONIC dishwasher	p.	40-42
TECHNICAL CHARACTERISTICS	p.	43
Electrical / Functional characteristics	p.	44-47

The Purpose of this Service Manual

The purpose of this Service Manual is to provide servicing technicians, who are already trained in the repair of traditional dishwashers, with specific and general technical information concerning the operating principles of the new electronic dishwasher which is marketed through the BUILT-IN sales channels (kitchen manufacturers).

The information contained in this Service Manual is of a general nature, and provides a description of all the possible technical applications for this type of dishwasher.

Descriptions of the functions of the components, the hydraulic circuit etc., which are already known to service technicians, are therefore excluded from this Manual.

Presentation

ITRONIC is the name given to a new type of dishwasher which features an electronic control system and a totally-integrated structure.

In effect, it is a “hybrid” dishwasher with an electronic control unit which controls, memorizes and performs the various functions. This control unit, together with the traditional hydraulic circuit (TCR), gives the appliance its superior performance.

The appliance is designed to be built into an element of the kitchen furniture. With its personalized styling and sophisticated control panel, which represents a user-friendly interface, the ITRONIC dishwasher offers performance which will meet the expectations of the user.

Two versions are produced, each in depths of 45 cm and 60 cm. The two series are known as:

- ITRONIC “HL” - LUXURY series
- ITRONIC “LL” - STANDARD series

This Service Manual describes the ITRONIC “LL” series.

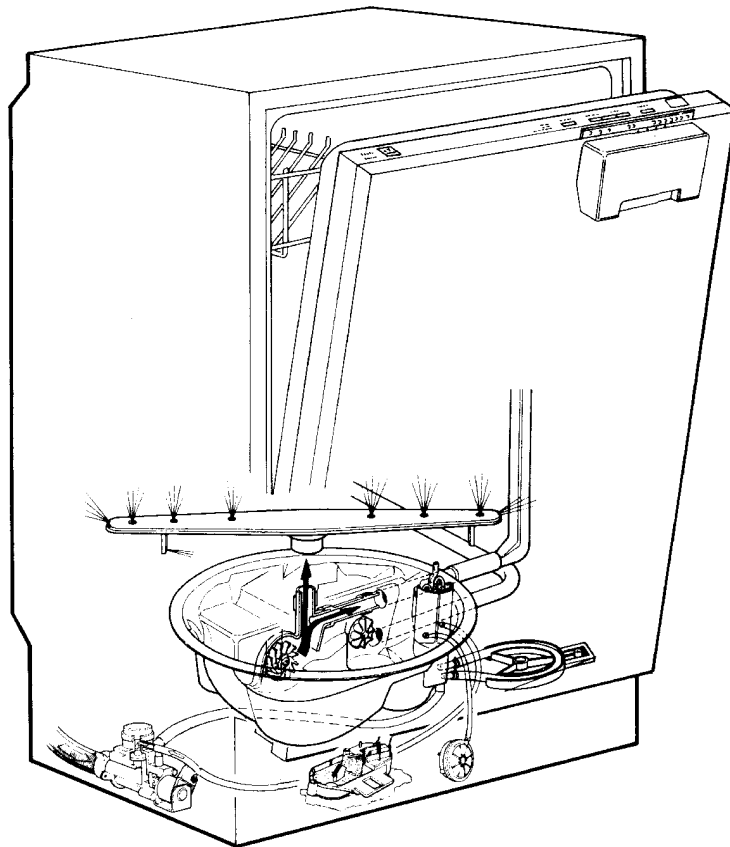

Innovative technical characteristics

The use of a microprocessor control unit and electronic sensors represents a substantial advance in the technical and functional characteristics of the dishwasher, as the appliance can be "personalized" using a computer-controlled system.

The data required to "personalize" the various types of dishwashers are entered into the microprocessor using a Personal Computer and a system which makes it possible to memorize and permanently store all the information entered.

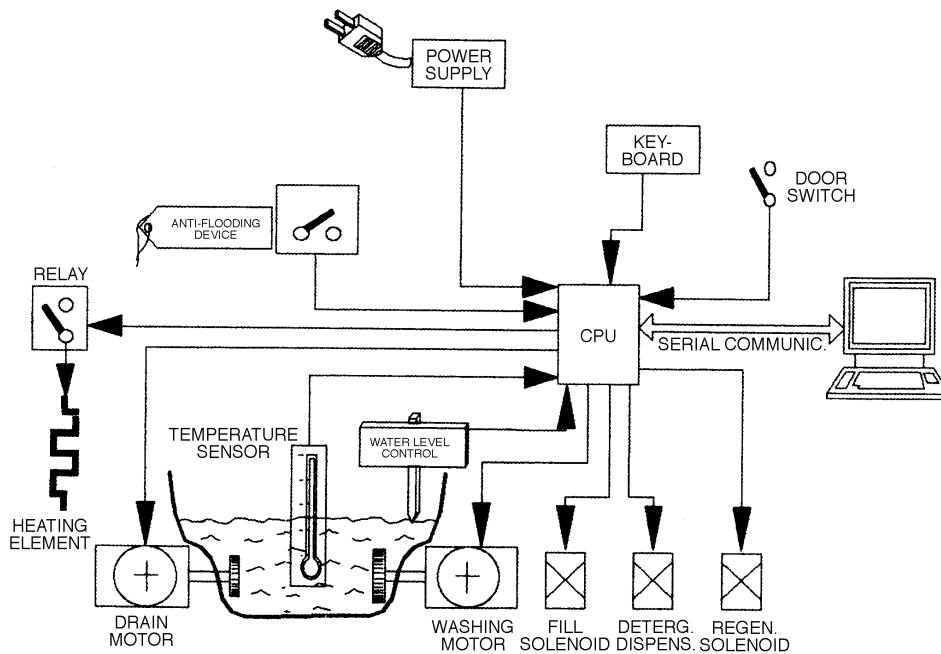

ITRONIC is an innovative dishwasher which has been specifically designed to meet the expectations of the most demanding user, with further improvements in the most essential functions:
Performance, Ecology, Safety.

Performance

Washing programmes	A high degree of flexibility in using the programmes, thanks to the electronic board containing a series of different programmes which guarantee excellent washing results for all types of dishes and soiling.
Ease of operation	The use of a “personalized” control panel with digital displays makes the appliance extremely easy for the user to operate.

Ecology

Silent operation	New technologies and new materials have made it possible to reduce noise to a minimum, thus assuring an appliance which operates in almost total silence.
Respect for the environment	Special technical and functional features have made it possible to reduce the consumption of <u>electricity</u> , <u>time</u> , <u>detergent</u> and <u>salt</u> - a significant saving in energy.

Safety

The absolute safety of the user during operation is guaranteed by the use of sophisticated safety devices - mechanical, hydraulic and electronic (software).

NOTE

A further innovative feature of this new dishwasher is the use of modular wiring (as is already used in washing machines), for which certain components have been modified for use with the new connectors.

Although their technical characteristics and positions remain unaltered, some of these components differ from those used in traditional dishwashers only in the use of these new connectors.

Others, such as the temperature sensor and the electronic control board, are used for the first time.

Structural characteristics

STRUCTURE - Totally Integrated

SLIM 45 cm

LOAD CAPACITY - 8 place settings (IEC)

CONSUMPTION

- Water	- 18 l
- Electricity	- 1.3 kWh

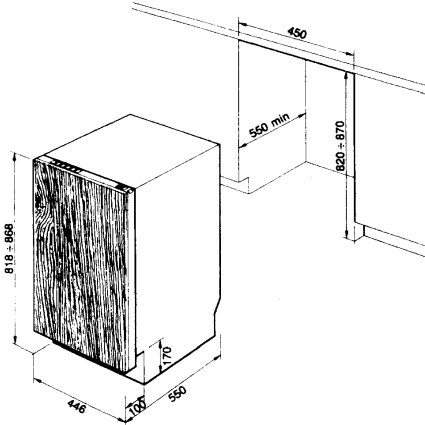
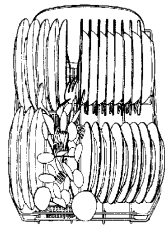
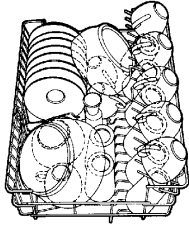

H.E. 60 cm (long door)

STRUCTURE - Totally Integrated

LOAD CAPACITY - 12 place settings (IEC)

CONSUMPTION

- Water	- 22 l
- Electricity	- 1.5 kWh

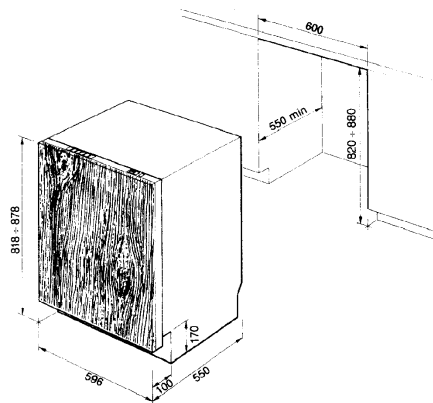
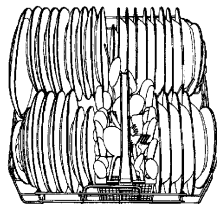
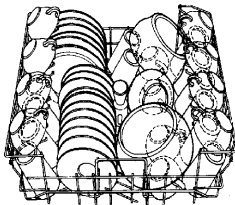

Control panel

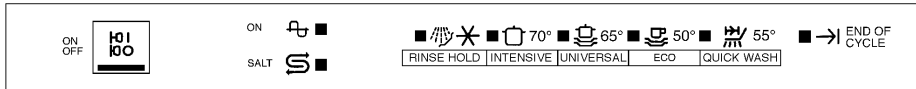

“ON/OFF” button

- Used to switch the appliance on and off.

“ON” LED (green)

- The “ON” LED lights when the machine is switched on.

“SALT” LED* (red)

- The “SALT” LED lights to indicate that the regenerating salt requires topping up. If **Level 1** has been entered, this LED remains unlit.

“PROGRAMME” buttons

- The “PROGRAMME” buttons can be used only when the door is open.
- When the buttons are pressed lightly, a signal to perform a specific function is sent to the electronic control board.
- Each button selects a specific programme.
- Pressing the buttons selects or cancels the programme.
- A LED on each button indicates the name of the programme.

“PROGRAMME” LEDs (green)

- The functions of the “PROGRAMME” LEDs refer to the programme button below.
- Only one LED can light at any time (more than one LED cannot light simultaneously).
- If a LED flashes at normal frequency, the relative programme has been selected but has not yet started.
- If a LED remains lit, the programme selected is in operation.
- If a LED flashes at double the standard frequency, a fault has occurred and the appliance has entered ALARM mode.
- If a LED is not lit, the programme has ended or has been cancelled; no function is therefore in operation.

“END OF CYCLE” LED (green)

- If the “END OF CYCLE” LED is not lit, the programme is in operation or is being selected.
- If this LED flashes at standard frequency, the washing programme has ended.

* Not featured on all models.

CHARACTERISTICS OF THE COMPONENTS

Electronic Control Unit

Control/display board

- This is the main control component, and determines and displays the functions of the dishwasher.
- It represents the interface between the user and the appliance.
- By pressing the various buttons, the user can select or cancel the various programmes.
- The LEDs on each of the buttons light to indicate the function selected.
- A buzzer sounds at varying frequencies whenever one of the buttons is pressed.
- This board is a single component which is inserted into a special casing and positioned behind the control panel.

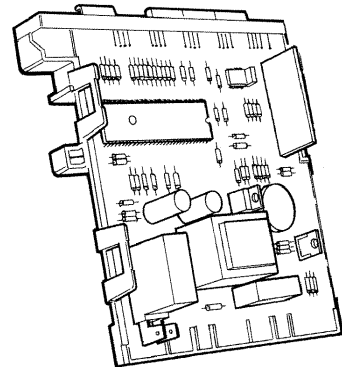
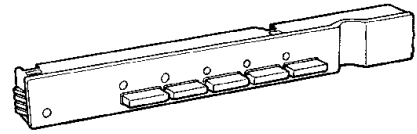

Microprocessor

- The microprocessor is built into the control board.
- The microprocessor controls all the functions performed by the appliance (programmes, control procedures, safety devices etc.), which are stored in permanent memory.

Temperature sensor

- The temperature sensor, which measures the temperature of the water, is an NTC variable-resistance sensor. The resistance (in Ohms) decreases as the temperature increases).
- The sensor is connected electrically to the control board.
- The sensor is positioned in contact with the inner door with a thin layer of thermoconductive silicon paste.

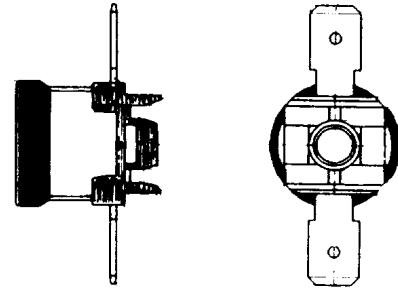

Resistance (Ohm) vs. Temperature (°C)

T. (°C)	R. (Ohm)	T. (°C)	R. (Ohm)
0	160.760	45	20.310
5	125.100	50	16.540
10	97.970	55	13.495
15	76.770	60	11.070
20	60.545	65	9.135
25	48.410	70	7.575
30	38.550	75	6.300
35	31.010	80	5.260
40	25.060	85	4.410

Electromechanical control components

ON/OFF switch

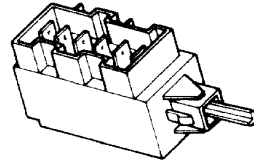

Door lock

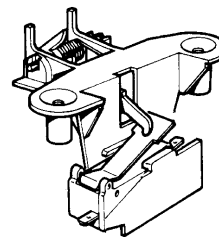

**Solenoid valve with
Anti-flooding device**

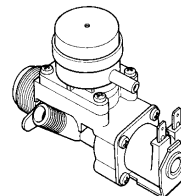

Level control device

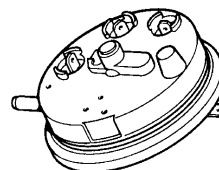

**Integrated detergent/rinse-aid
dispenser**

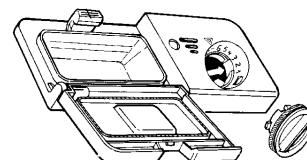

Heating element

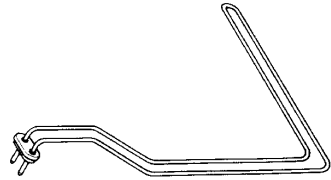

Safety thermostat

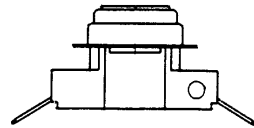

**Drain pump
(synchronous motor)**

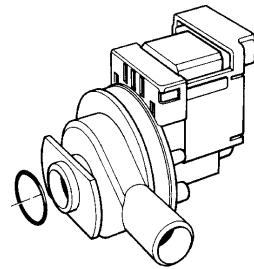

**Washing pump
(asynchronous motor)**

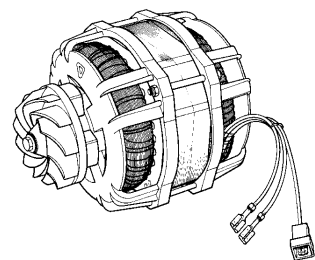

Hydraulic components

Regeneration tank

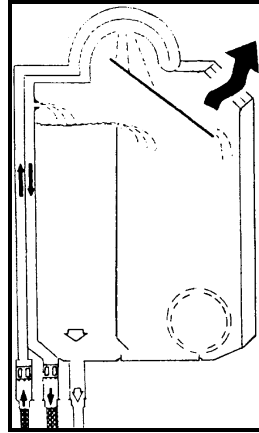

Water softener

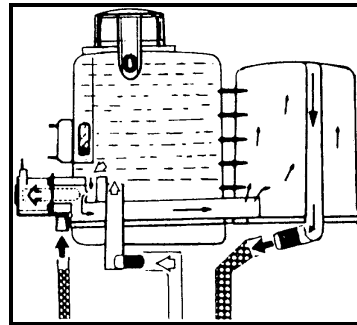

Sump assembly

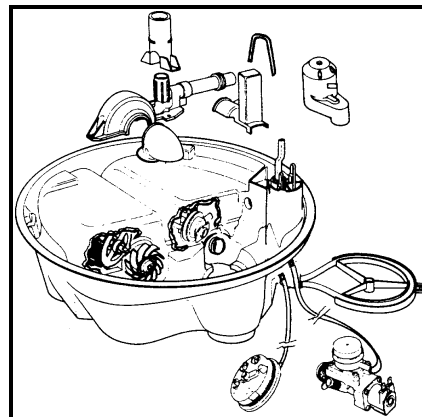

FUNCTIONAL CHARACTERISTICS

Washing system

The electronic control unit performs all the actioning functions and control of the operations.

The hydraulic system is characterized by the rotational movement of two separate spray arms, which are positioned underneath the two baskets containing the dishes.

The washing pump directs water simultaneously to the two spray arms (directly to the lower arm, and via a duct to the upper arm).

The position, number and shape of the spray nozzles on the two spray arms ensure that the arms rotate smoothly and that the water is sprayed evenly and with constant force onto all the surfaces of the dishes.

The combination of all these features gives an appliance which is simple and modern, and guarantees excellent washing results.

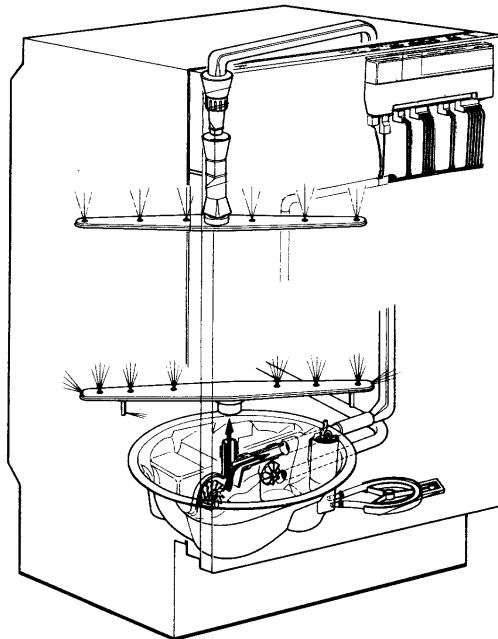

Hydraulic circuit

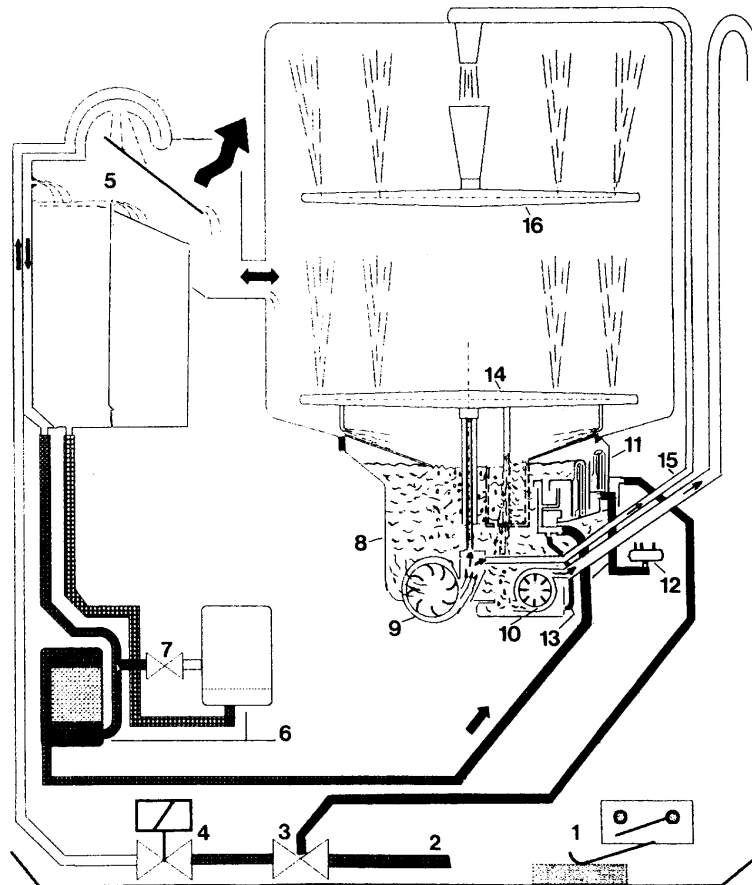

- | | |
|--------------------------|-----------------------------|
| 1. Anti-flooding device | 9. Washing pump |
| 2. Water intake hose | 10. Drain pump |
| 3. Anti-overflow device | 11. Sump (chamber section) |
| 4. Water intake solenoid | 12. Pressure switch |
| 5. Regeneration tank | 13. Circulation hose |
| 6. Softener | 14. Lower spray arm |
| 7. Regeneration solenoid | 15. Duct to upper spray arm |
| 8. Sump assembly | 16. Upper spray arm |

Water intake

Water intake takes place in three sequential phases:

- Static intake: 40 seconds (washing motor stopped)
- Dynamic intake 20 seconds (washing motor in operation)
- Static intake x seconds (washing motor stopped) until the pressure switch level is reached (max. 240 seconds).

During the water intake phase, a software safety feature (TIME OUT) ensures that the correct water level is reached within a maximum of 5 minutes.

Control of water level

- Chamber sections:
- A** = Pressure switch level
 - B** = Anti-overflow level

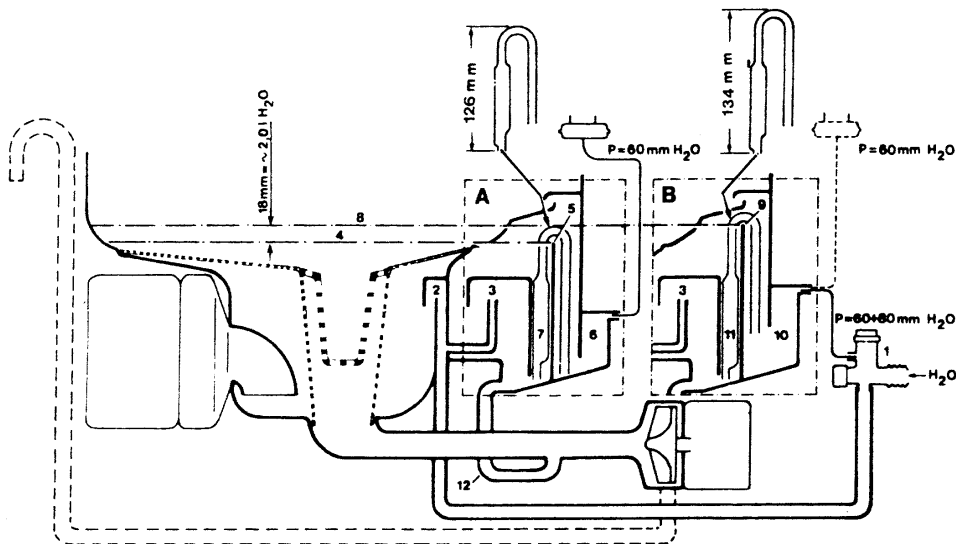

- | | |
|---|--|
| 1. Water from solenoid valve | 7. Pressure switch level siphon |
| 2. Water intake to sump | 8. Anti-overflow water level |
| 3. Water intake to chamber section | 9. Anti-overflow overflow point |
| 4. Level of washing water | 10. Connection chamber for anti-overflow |
| 5. Overflow point for level pressure switch | 11. Anti-overflow siphon |
| 6. Pressure switch connection chamber | 12. Circulation hose: chamber section/sump |

Water softener

The dishwasher features a water softening system which is designed to soften the water to 90° TH (French), which is equivalent to 50° dH (German).

Each washing programme (with the exception of the RINSE & HOLD programme) includes phases memorized by the microprocessor which, according to the level of hardness selected, controls and optimizes the regeneration function.

The hardness of the water is sub-divided into **5 levels**. The functions are as follows:

Level	Function
1	- No regeneration
2 - 3	- Regeneration during hot-water rinse phase
4 - 5	- Regeneration during wash phase (supplementary) - Regeneration during hot-water rinse phase

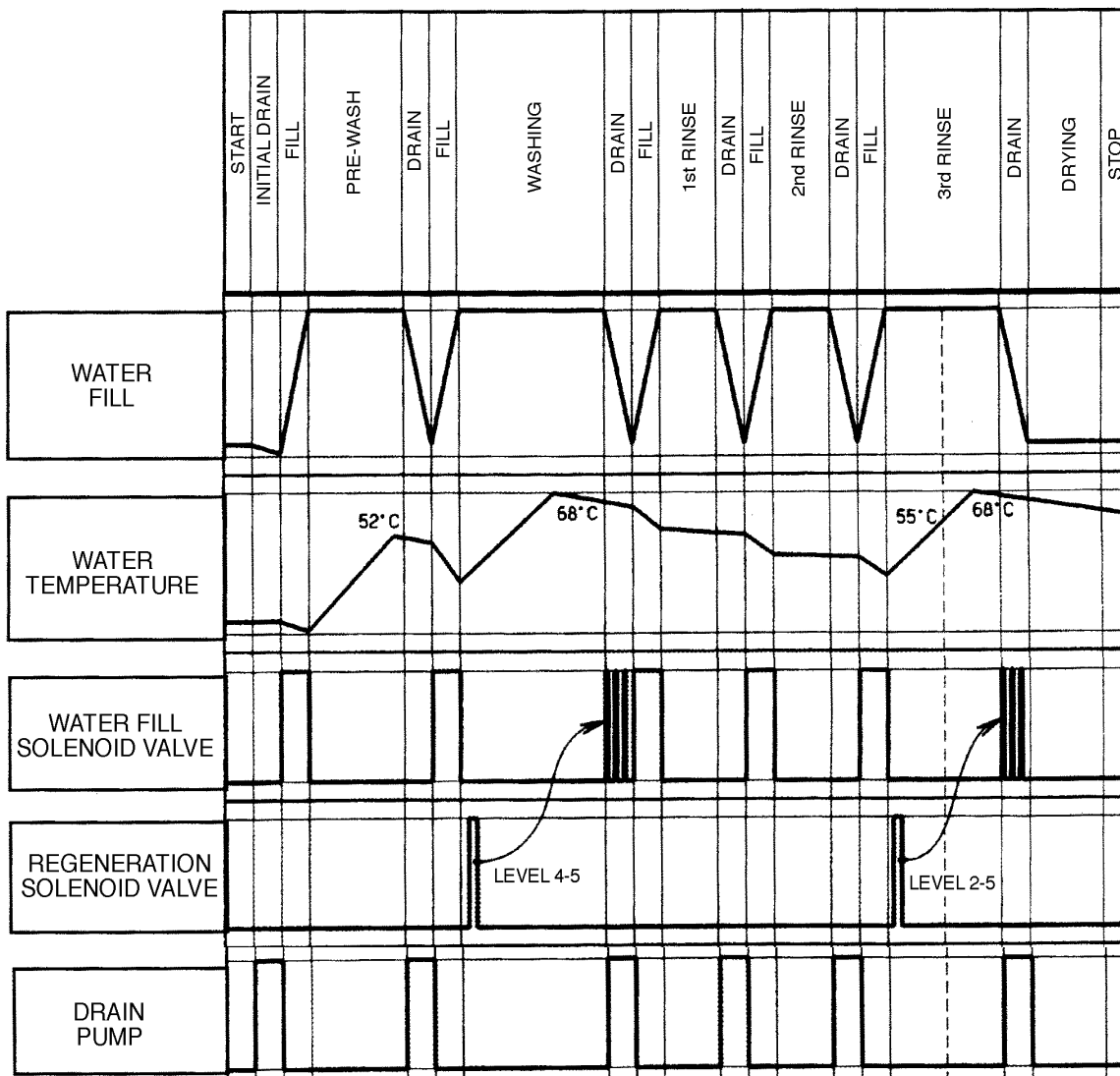

Regulation of the water softener

The water softening system is regulated using the five buttons used to select the programmes.

Each button selects one of the five regeneration levels memorized by the microprocessor.

Regeneration Levels associated with Programme Buttons

Regeneration Level	Programme Button
1	RINSE & HOLD
2	INTENSIVE
3	UNIVERSAL
4	ECO/BIO
5	QUICK WASH

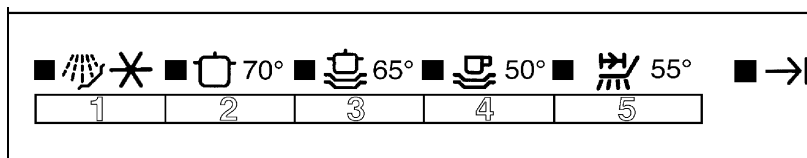

Selecting the REGENERATION LEVEL

Important: The regeneration level can be selected only during the programme setting phase (i.e. before starting the washing programme).

With the door open: - Prepare the appliance in the programme setting phase.

Appliance switched on

- If necessary, press the ON/OFF button to switch the appliance on.
- Hold down programme buttons 3 and 5 (“UNIVERSAL” and “QUICK WASH”) for five seconds, until the LED for the INTENSIVE button (2) begins to flash.
- To modify the regeneration level (within five seconds), press the programme button corresponding to the desired level (e.g. to select level 4, press the ECO-BIO button). The LED on the button flashes to indicate the new setting.
- Five seconds after one of the buttons has been pressed, the setting is memorized and the appliance automatically returns to the programme setting phase.

Level	°F (°TH)	°D ((°dH)
1	0 - 14	0 - 7
2 *	15 - 39	8 - 21
3	40 - 50	22 - 28
4	51 - 70	29 - 39
5	71 - 90	40 - 50

* The dishwasher is set to level 2 in the factory

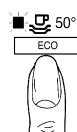
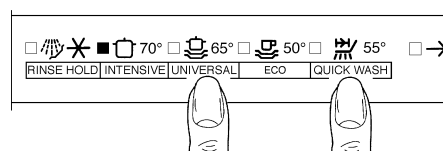

Operating principles of the regeneration system

During the regeneration phase, the microprocessor opens the regeneration solenoid valve for a predetermined time (depending on the level of regeneration selected). This time is between 10 seconds (minimum) and 60 seconds (maximum).

The water contained in the regeneration chamber flows by gravity into the salt reservoir, and the valve (now open) pumps the salty water (brine) into the resin reservoir.

This function serves to clean the resins, i.e. to dissolve the calcareous salts and minerals trapped by the resins.

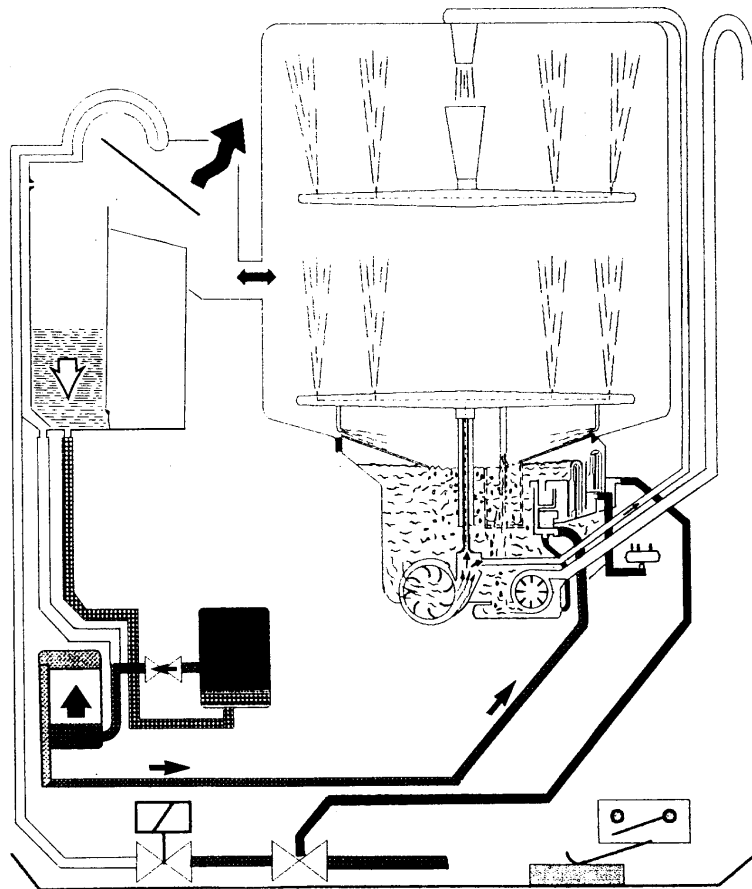

Washing the resins

This function serves to regenerate the resins, i.e. to remove the brine together with the calcareous salts and minerals from the resins, thus restoring the resins to maximum efficiency.

During this phase, the microprocessor simultaneously actions the intake solenoid valve and the drain pump (intake and drain) for a predetermined period.

The water passes through the solenoid valve into the resin reservoir, thus forcing the brine from the resin reservoir into the sump. The drain pump expels the brine through the drain hose, thus ensuring that it does not come into contact with the walls of the tub (in stainless steel) and the dishes.

This completes the regeneration phase.

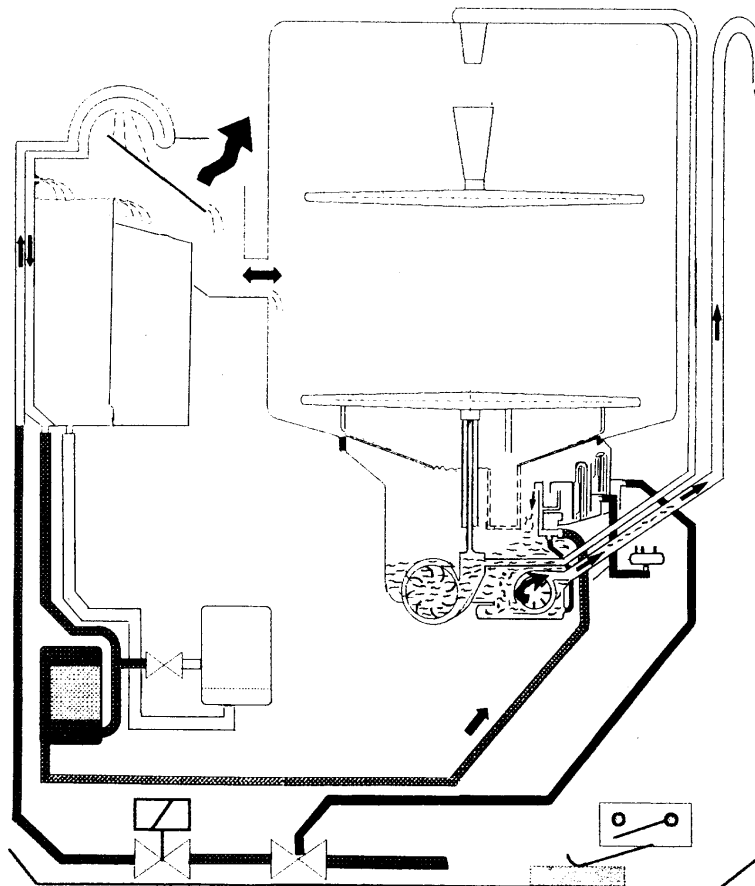

CONTROL, SAFETY AND ALARM DEVICES

Safety checks

Control devices (software, mechanical and hydraulic) constantly monitor the appliance when in operation in order to ensure that each component functions correctly. In case of a malfunction, one or more of the safety devices immediately intervenes.

The following safety devices are in operation when the washing programmes are being performed:

Programme in operation

When the door is closed and the washing programme is started, it is no longer possible to modify the selected settings. This means that the settings cannot be altered inadvertently.

The programme being performed can be cancelled by pressing the corresponding button for 2 seconds.

Power failure

In case of a power failure, the electronic memory indefinitely maintains the information relative to the programme being performed.

When power is restored, the programme resumes from the point at which it was interrupted.

Anti-overflow device (mechanical / hydraulic)

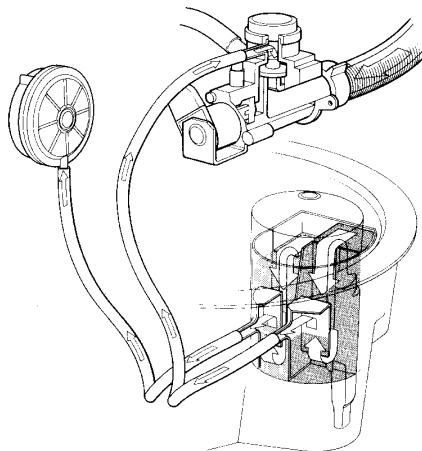

Anti-flooding device * (electromechanical / hydraulic)

* Not featured on all models.

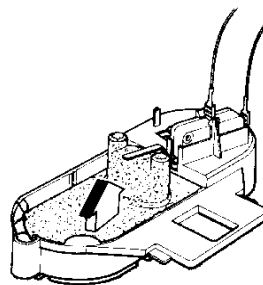

Safety devices / Alarms

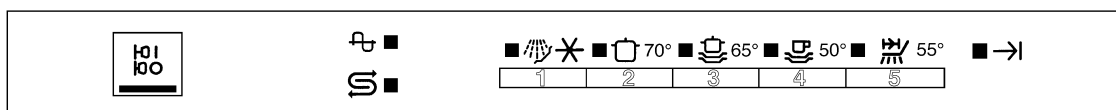

When one of the safety devices intervenes, an “Alarm Code” flashes at twice the standard frequency of the programme LEDs.

During the course of a washing programme, a flashing LED indicates that one of the “Alarm Codes” has occurred.

Operation of the dishwasher is interrupted, and all its functions are disabled; the buttons are all deactivated, with the exception of the ON/OFF button.

Alarm codes			Safety systems activated	
1			Time-out	Water intake
2		70°	Time-out	Water replenishment
2		70°	Time-out	Pressure switch on empty (awaiting temperature)
3		65°	Time-out	Temperature sensor
4		50°	Time-out	Water heating
5		55°	Time-out	Pressure switch on empty (end of drain)

Resetting / cancelling the alarm

To reset or cancel the alarm condition, switch off the appliance by pressing the ON/OFF button.

When the ON/OFF button is pressed again, the appliance returns to the programme setting phase, in which the washing cycle can be re-selected or a new cycle entered.

If the fault persists, the appliance returns to the **Alarm** condition.

Time-out - Water intake

- The maximum duration for the water fill is **5 minutes**.
- The Time-out count begins at the start of each water intake phase and ends when the pressure switch “full” signal (1 - 3) is received.
- If the time necessary for the pressure switch (1 - 3) to reach “full” is more than **5 minutes**, the machine goes to the alarm condition.
- The LED corresponding to the programme being performed switches off.

Identification

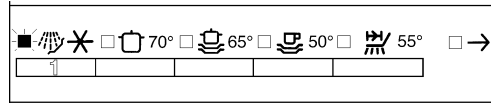

Dishwasher stopped.
When the door is opened:

LED “1” flashes at double frequency
The remaining LEDs are unlit.

Time-out Water replenishment

- After resetting of the pressure switch, the maximum time allowed for water replenishment is **45 seconds**.
- The time-out safety device is in operation when the level is reached (pressure switch “full” 1 - 3) and remains in operation until the following drain cycle.
- The time-out count begins as soon as the pressure switch resets to “empty” (1 - 2) and ends when the “full” signal (1 - 3) is restored.
- If the time necessary for the pressure switch signal (1 - 3) to go back to “full” is more than **45 seconds**, the machine goes to the alarm condition.
- If more than one replenishment takes place because the pressure switch resets to “empty” (1 - 2) more than once, the total time for replenishment must not exceed **45 seconds**; if this occurs, the machine goes to the alarm condition.
- The LED corresponding to the programme being performed switches off.

Identification

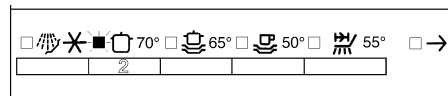

Dishwasher stopped.
When the door is opened:

LED “2” flashes at double frequency
The remaining LEDs are unlit.

Time-out Pressure switch “empty”

(waiting for temperature)

Conditions: This safety device is operative only while the water is being heated, excluding the drying phase.

- If the pressure switch resets to “empty” (1 - 2), **2 minutes** are allowed until the pressure switch returns a “full” signal (1 - 3).
- If the “full” signal (1 - 3) is not received within **2 minutes**, the cycle is interrupted and the appliance goes to the alarm condition.
- If the pressure switch resets to “empty” (1 - 2) more than once while waiting for the water to reach the correct temperature, these resets may occur not more than **3** times.
If a further reset occurs, the cycle is interrupted definitively and the appliance goes to the alarm condition.
- The LED corresponding to the programme being performed switches off.

Identification

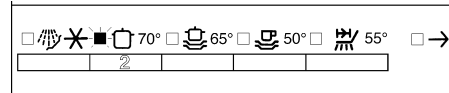

Dishwasher stopped.
When the door is opened:

LED “2” flashes at double frequency
The remaining LEDs are unlit.

Time-out Temperature sensor

(broken/short-circuited)

- Correct operation of the temperature measurement circuit is monitored during the entire washing cycle.
- Two intervention thresholds have been entered. The lower threshold is **-5°C**, the upper threshold is approximately **85°C**.
- If the temperature measured by the sensor is not within this range, the appliance goes to the alarm condition.
- The LED corresponding to the programme being performed switches off.

Identification

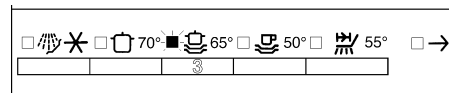

Dishwasher stopped.
When the door is opened:

LED “3” flashes at double frequency
The remaining LEDs are unlit.

Time-out Water heating

- The maximum time allowed for water heating (irrespective of the temperature of the cycle selected) is **45 minutes**.
- The time-out count begins at the start of each water heating phase (when the heating element switches on) and ends when the appropriate temperature has been reached.
- If the time required to heat the water to the appropriate temperature exceeds **45 minutes**, the appliance goes to the alarm condition.
- During the final drying phase (after the final hot rinse has been drained), this safety system becomes inoperative.
- The LED corresponding to the programme being performed switches off.

Identification

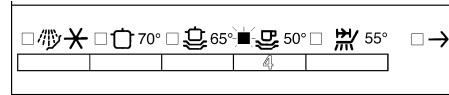

Dishwasher stopped.
When the door is opened:
LED "4" flashes at double frequency
The remaining LEDs are unlit.

Time-out Pressure switch "empty" (end of drain)

- At the end of each drain phase, the pressure switch is checked to ensure that it is in the "empty" position (1 - 2).
- If at the end of the drain phase the pressure switch is found to be in the "full" position (1 - 3), the appliance goes to the alarm condition.
- The LED corresponding to the programme being performed switches off.

Identification

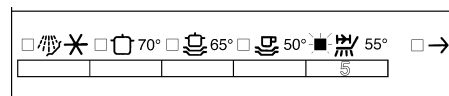





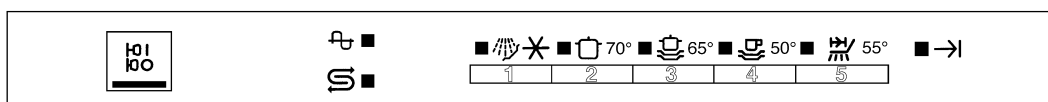

Dishwasher stopped.
When the door is opened:
LED "5" flashes at double frequency
The remaining LEDs are unlit.

Checking the Alarm Conditions



The table below shows the most likely causes of the alarm conditions that may be displayed on the control panel, together with suggestions for solving the problem.

ALARM CONDITION	TIME OUT	CAUSES
1 <input type="checkbox"/>  	<p style="text-align: center;"><u>Water fill</u></p> <p>Maximum time allowed 5 min. during each water fill phase.</p>	<ul style="list-style-type: none"> - Tap closed. - Mains pressure insufficient. - Intake hose filter blocked. - Solenoid valve inoperative. - Siphon effect on drain hose. - Anti-overflow device has intervened. - Anti-flooding device has intervened. - Control board faulty.
2 <input type="checkbox"/>  70°C	<p style="text-align: center;"><u>Water replenishment</u></p> <p>Maximum time allowed 45 seconds (even when more than one replenishment occurs).</p> <p style="text-align: center;"><u>Pressure switch “empty”</u> (waiting for temperature)</p> <p>Maximum time allowed: 120 seconds, maximum 3 times.</p>	<ul style="list-style-type: none"> - Water leakage from the sump or couplings. - Siphon effect on drain hose. - Circular filter blocked. - Dishes overturned. - Pressure switch faulty. - Pressure switch tube leaks. - Control board faulty.
3 <input type="checkbox"/>  65°	<p style="text-align: center;"><u>Temperature sensor</u></p> <p>Instantaneous intervention during the entire cycle. Range of intervention -5°C/85°C</p>	<ul style="list-style-type: none"> - Temperature sensor broken or incorrectly set. - False or interrupted contacts. - Temperature lower than -5° C. - Temperature sensor short-circuited. - Connections short-circuited. - Temperature higher than 85° C. - Control board faulty.
4 <input type="checkbox"/>  50°	<p style="text-align: center;"><u>Water heating</u></p> <p>Maximum time allowed: 45 min. (excluding the drying phase)</p>	<ul style="list-style-type: none"> - Heating element broken. - False or interrupted connections. - Safety thermostat open. - Temperature sensor incorrectly calibrated or out of position (poor contact) - Circular filter blocked. - Water level too low. - Upper spray arm blocked. - Control board faulty.
5 <input type="checkbox"/>  55°	<p style="text-align: center;"><u>Pressure switch “empty”</u> (end of drain)</p> <p>Instantaneous intervention at the end of each drain cycle.</p>	<ul style="list-style-type: none"> - Drain pump does not function. - Drain hose obstructed. - Chamber drainage siphon does not function. - Circulation tube obstructed or out of position. - Pressure switch jammed on “full” (1 - 3). - Control board faulty.

FUNCTIONS AND CONTROLS

Functional characteristics of controls

The functional operation of the controls is sub-divided into three phases:



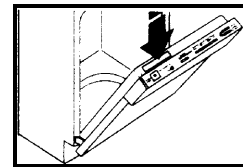
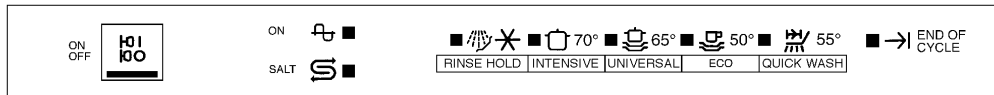

SETTING - PROGRAMME EXECUTION - END OF PROGRAMME, during which a BUZZER sounds at different frequencies to signal the settings selected and the corresponding functions.

The controls are positioned on the upper edge of the door. The door must be slightly open in order to inspect and/or use the control panel.



SETTING

Switching on

- When the ON/OFF switch is pressed, the appliance switches on and the desired programmes can be selected.
- The **ON** LED   lights when the appliance is switched on.
- The **SALT** LED   may also light at this point.

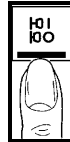

Programme selection

- The buttons on the control panel can be used to select from five different washing programmes.
- Each button corresponds to a specific washing programme.
- Each time one of the buttons is pressed, a short acoustic signal confirms that the selection has been confirmed.
- At the same time, the corresponding LED lights.

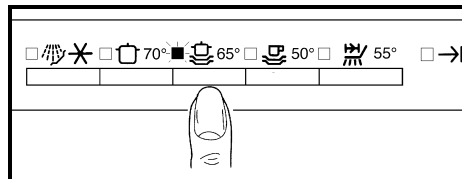

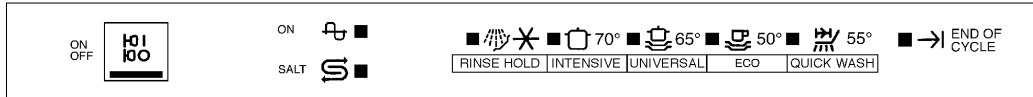

Topping up the salt

- The **SALT** LED lights when the salt reservoir is empty.
- If the water hardness is set to **level 1**, this LED remains switched off since no salt is required for regeneration.

BUZZER

- The buzzer is programmed to sound in all phases of the cycle.
- To switch the buzzer function on and off, it is necessary to press a combination of two buttons.

Switching off the BUZZER

- Press programme buttons 3 and 4 (“UNIVERSAL” + “ECO”) simultaneously for about three seconds.
- Three short signals confirm that the buzzer function has been switched off.

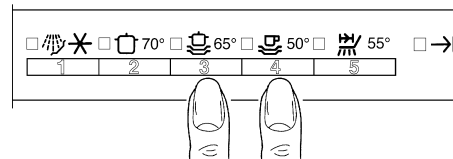

Switching on the BUZZER

- Press programme buttons 3 and 4 (“UNIVERSAL” + “ECO”) simultaneously for about three seconds.
- A series of intermittent signals confirms that the buzzer function has been switched on.

Start

- When the door is closed, the selected programme immediately begins, e.g. the appliance goes from the **programme setting** phase to the **programme execution** phase.
- A short acoustic signal confirms that the programme has started.

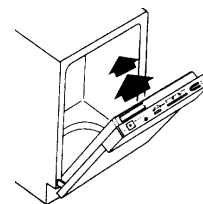

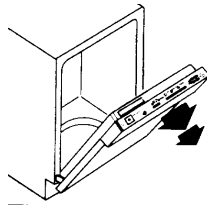
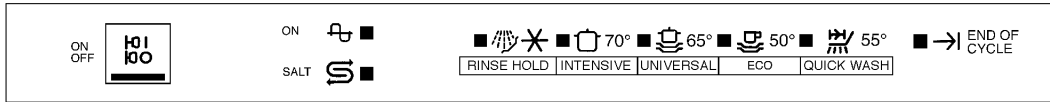

PROGRAMME EXECUTION

If the door is opened:

- The programme is interrupted, but the current phase (i.e. the point at which the programme is interrupted) is stored in memory.
- The LED corresponding to the programme selected remains lit.
- The selected programme is stored in memory and cannot be modified (it may only be cancelled or reset).

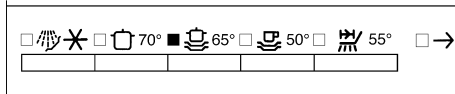

When the door is re-closed:

- The programme resumes from the point at which it was interrupted.

Interrupting the programme:

- Open the door. The programme LED is lit.
- When the ON/OFF button is pressed, the programme is interrupted and the LED switches off.
- When the ON/OFF button is pressed again, the LED lights and, when the door is closed, the programme resumes from the point at which it was interrupted.



Cancel / Reset the Programme

- Open the door. The programme LED is lit.
- Press the corresponding button for 2 seconds. The LED switches off and a short signal confirms that the programme has been cancelled.
- The dishwasher returns to the programme setting phase.

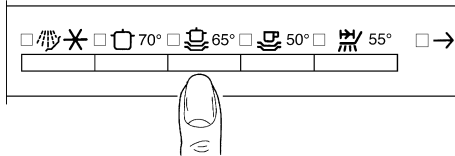

END OF PROGRAMME

- An acoustic signal sounds at intervals of 5 seconds to indicate that the programme has ended.
- Open the door.
- The LED corresponding to the programme that has ended is off.
- The "END OF CYCLE" LED flashes to confirm that the programme has ended.

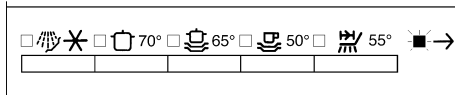

TROUBLESHOOTING

Checking the components for efficiency

As an aid to the trouble-shooting procedure, the connectors fitted to the control board can be detached, and a standard tester can be used to measure the resistance and thus check the efficiency of each component fitted to the dishwasher.

In order to make testing of the components quicker, refer to the CONTROL PROCEDURE in the table on the following page, which shows the terminals to which the tester probes should be applied and the correct values for the component.

The casing of the control board is marked with the letters A, B, C, D, E, F and G, which identify the correct position of each of the connectors.

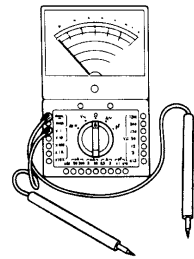
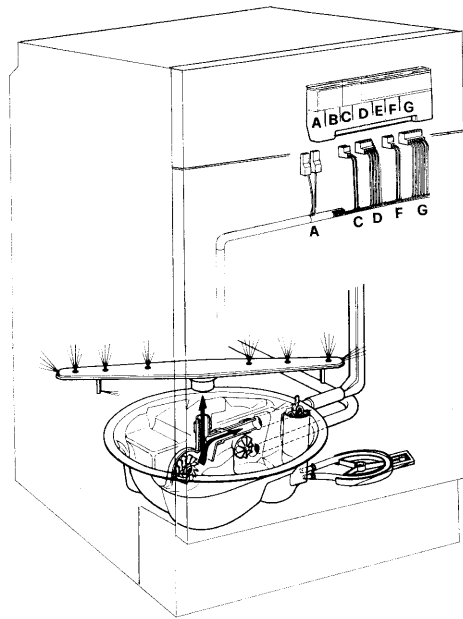

Procedure: Apply the tester probes to the points listed in the table and measure the value of the component.

Component	Tester probes on	Correct value
Power cable and main switch	 L - C2 N - A1	Button released: Open Button pressed: Short-circuited
Heating element and safety thermostat	A2 - C1	at 20°C 1900W = 25 Ohm 2800W = 18 Ohm
Door switch	C2 - C1	Door open: Open Door closed: Short-circuited
Temperature sensor	D4 - D3	at 20° C = 60.545 Ohm at 50° C = 16.545 Ohm at 65° C = 9.135 Ohm
Integrated distributor	D2 - D1	1.300 Ohm
Rinse-aid sensor	E2 - E3	With rinse-aid: Open Without rinse-aid: Short-circuited
Salt sensor	F2 - F1	With salt: Open Without salt: Short-circuited
Level regulator	G6 - G5	Empty (1-2): Open Full (1-3): Short-circuited
Regeneration solenoid valve	G6 - G4	3600 : 4400 Ohm
Drain pump	G6 - G3	170 Ohm
Intake solenoid and anti-flooding device	G6 - G2	3600 : 4400 Ohm
Washing pump	G6 - G1	Start winding = 24 Ohm Auxiliary winding = 65 Ohm
	This measurement must be made directly on the motor between wires "B2" and "MA-GR".	

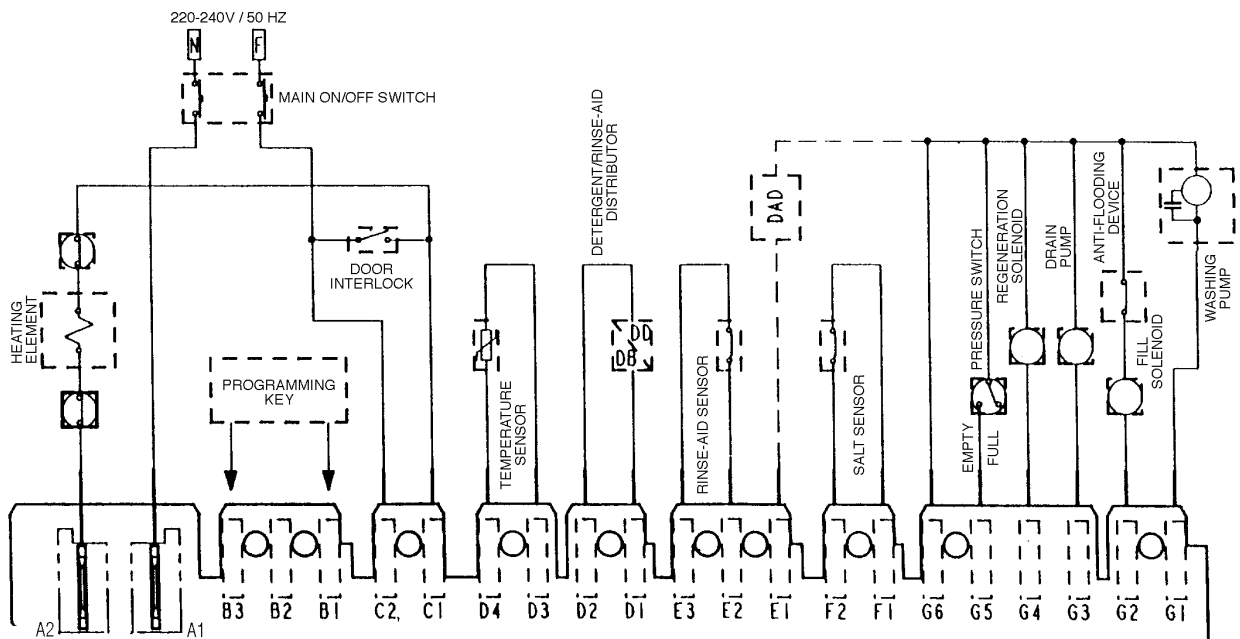

Programming optional features on the ITRONIC dishwasher

Dishwashers in the ITRONIC range feature an electronic control board with a microprocessor containing all the basic programmes and functions.

When the appliance is being prepared in the factory, the main electronic board can be configured, i.e. “personalized” by entering supplementary functions which respond to the requirements of the specific market.

Configuration of the main control boards makes it possible to produce the nine different types of “personalized” board containing the various options associated with each identification code.

Identification of the control board

An adhesive sticker affixed to the casing of the board shows the technical data relative to the control board and a code (e.g. 152.204.20/.) which identifies the main board.

If the control board has been “personalized” in the factory, a second adhesive sticker is affixed to the casing. This sticker is printed with a code (e.g. 152.204.23/.) which identifies the way in which the board has been “personalized” for that dishwasher model.

The possibility of “personalizing” the control board offers an advantage in that the main board can be used (and managed as a spare part) by itself, while the “personalization” options can be entered on the board fitted to the machine.

Note: If the “personalization” sticker is not affixed to the casing of the control board, this means that the appliance is fitted with the main board and that no supplementary options have been added.

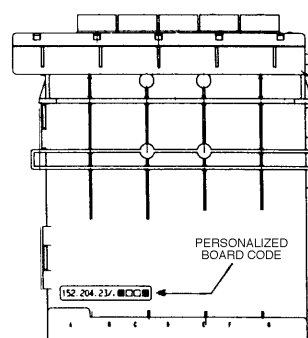
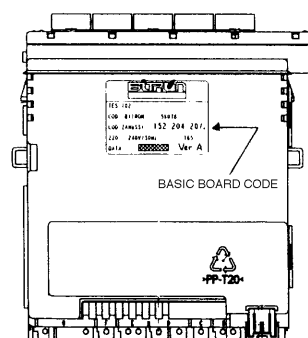

Configuration of the control board

The functions for each dishwasher model depend on the country in which it is to be sold. For this reason, supplementary functions (options) can be added to the main board to meet the particular requirements of each market.

“Personalization” (i.e. the addition of various options) is performed on the board after it has been fitted to the appliance. The procedure for “personalization” may be performed only by qualified technical operators.

If it is “personalized”, the main electronic board may be set in a variety of configurations.

In order to ascertain the configuration of the options, it is necessary to compare the “personalization” code affixed to the casing of the board with the way in which the four programme LEDs light (steady or flashing).

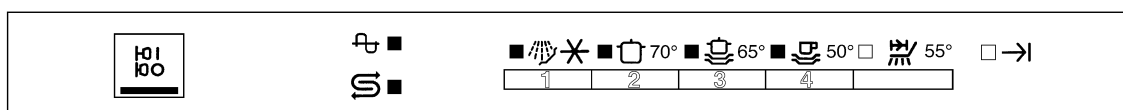

Main board code	Personalized board code	LEDs				Option A	Option B	Option C	Option D
		1	2	3	4	■ □ ✕	■ □ 70°	■ □ 65°	■ □ 50°
152.204.20/.		F	F	F	F	-	-	-	-
	152.204.21/.	F	F	F	L	-	-	-	X
	152.204.22/.	F	F	L	L	-	-	X	X
	152.204.23/.	L	F	F	L	X	-	-	X
	152.204.24/.	L	F	L	L	X	-	X	X
	152.204.25/.	F	L	F	F	-	X	-	-
	152.204.26/.	F	L	F	L	-	X	-	X
	152.204.27/.	F	L	L	L	-	X	X	X
	152.204.28/.	L	L	F	L	X	X	-	X
	152.204.29/.	L	L	L	L	X	X	X	X

Key : Leds: L = Lit (steady)
 Leds: F = Flashing

Option A : Specific cycle for French market.
 Option B : Additional cold rinse (2 instead of 1).
 Option C : 65°C rinse in ECO-BIO cycle (instead of 55°C).
 Option D : 55°C hot rinse in QUICK WASH cycle (instead of cold).

Personalizing the control board

General :

This operation is performed on a few dishwasher models only, since most models are fitted with the main board without any supplementary options.

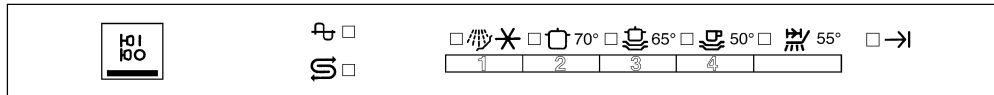

In order to “personalize” the control board, it is necessary first to remove the door using the special key (part code 152 28 56-00/2) which is contained in the control board kit.

Depending on the personalization code printed on the casing of the original board, proceed as follows:

Switch off the appliance.

- Insert the connector (key) into sector **B** of the control board.
- **Switch on the appliance:** The personalization phase begins.
- LEDs **1, 2, 3** and **4** begin to flash, indicating that no supplementary options have been entered.
- Press the programme button(s) corresponding to the codes shown in the table on page 41.
- The LED corresponding to the button that has been pressed will now remain lit steadily, while the remaining LEDs will continue to flash.
For example, for code 152.204.23/., press buttons **1** and **4**; the corresponding LEDs will remain lit.
- **Switch off the appliance.** The options are now stored in memory.
- Remove the connector (key) from the control board and refit the door.
- The electronic board has now been “personalized”.

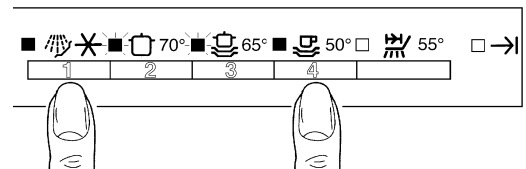
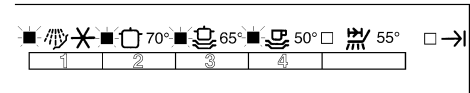
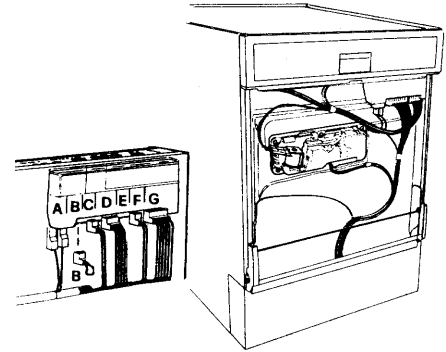

TECHNICAL CHARACTERISTICS

CIRCUIT DIAGRAM

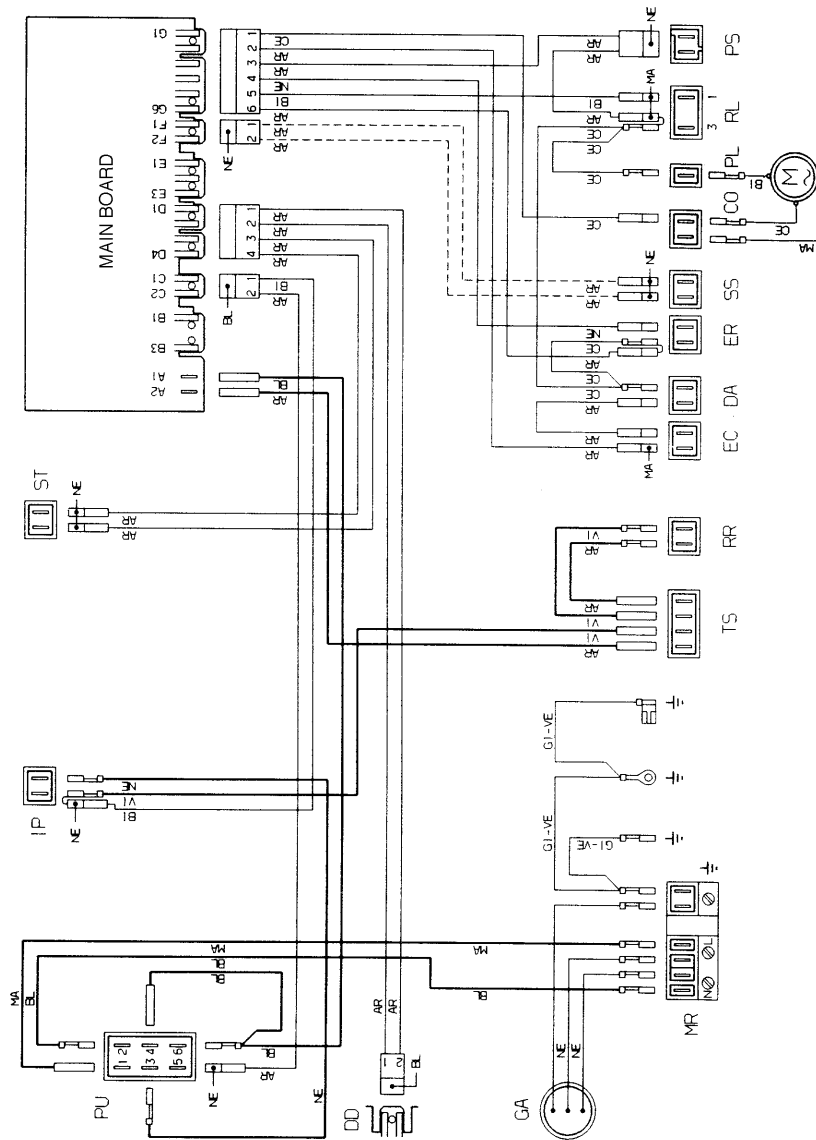

ar	ORANGE	bi	WHITE	bl	BLUE
ce	LIGHT BLUE	gr	GREY	ma	BROWN
ne	BLACK	ro	PINK	vi	PURPLE
CO	CAPACITOR	DA	ANTI-FLOODING DEVICE	DD	DETERGENT DISPENSER
EC	WATER FILL SOLENOID	ER	REGEN. SOLENOID	GA	INTERFERENCE FILTER
IP	DOOR SWITCH	KM	ELECTROMAGNET	LS	PILOT LAMP
MT	TIMER MOTOR	PL	WASH PUMP	PS	DRAIN PUMP
PU	PUSHBUTTON BOARD	RE	RELAY	RL	PRESSURE SWITCH
RP	TIME SWITCH	RR	HEATING ELEMENT	SB	RINSE-AID SENSOR
SD	DETERGENT SENSOR	SS	SALT SENSOR	TS	SAFETY THERMOSTAT

ITRONIC LL - CYCLES TABLE

PROG no.	PROGRAMME	RINSE & HOLD		WASH	1st RINSE	2nd RINSE	3rd RINSE	DRYING
		°C	min.	°C	min.	min.	°C	PAUSE/ HEATING
1	PREWASH		8					
2	INTENSIVE 70°C	52°		68°	5	5	68°	90" + 270" 45" + 30"
3	UNIVERSAL 65°		8	65°	5		68°	90" + 270" 45" + 30"
4	ECO 55°		8	55°	5		55°	90" + 270" 45" + 30"
5	QUICK WASH			55°	5		55°	

ITRONIC - CYCLE DIAGRAM

